

### FEATURES

- 18 precision gamma reference outputs
- Mask-programmable voltage regulator: 0.4% accuracy
- Upper 9 buffers swing to  $V_{DD}$
- Lower 9 buffers swing to GND
- Single-supply operation: 7.5 V to 16.5 V
- Gamma current drive: 15 mA per channel
- Peak output current: 150 mA
- Output voltage stable under load conditions
- 48-lead, Pb-free LQFP package

### APPLICATIONS

- LCD TV panels
- LCD monitor panels

### GENERAL DESCRIPTION

The ADD8709 is an 18-channel integrated gamma reference for use in LCD TV and monitors panels. The output buffers feature high current drive and low offset voltage to provide an accurate and stable gamma curve. The top nine channels swing to  $V_{DD}$  and the lower nine channels swing to GND.

An on-board voltage regulator provides a fixed input for the gamma buffers, isolating the gamma curve from supply ripple.

The ADD8709 is specified over the temperature range of  $-40^{\circ}\text{C}$  to  $+105^{\circ}\text{C}$  and comes in a 48-lead, Pb-free, low-profile quad flat package.

### FUNCTIONAL BLOCK DIAGRAM

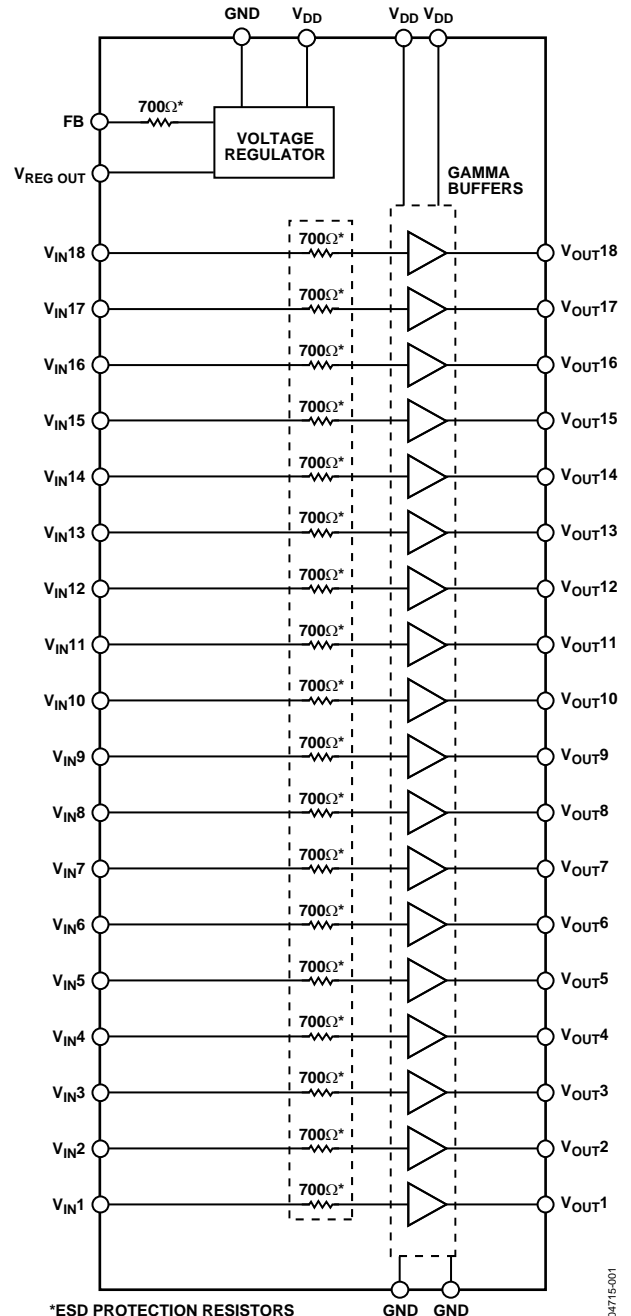

Figure 1. 48-Lead LQFP

### Rev. A

Information furnished by Analog Devices is believed to be accurate and reliable. However, no responsibility is assumed by Analog Devices for its use, nor for any infringements of patents or other rights of third parties that may result from its use. Specifications subject to change without notice. No license is granted by implication or otherwise under any patent or patent rights of Analog Devices. Trademarks and registered trademarks are the property of their respective owners.

**TABLE OF CONTENTS**

Electrical Characteristics ..... 3

Absolute Maximum Ratings..... 4

    ESD Caution..... 4

Pin Configuration and Function Descriptions..... 5

Typical Performance Characteristics ..... 7

Application Notes ..... 10

    Voltage Regulator ..... 10

    Maximum Power Dissipation ..... 10

    Operating Temperature Range ..... 10

Typical Applications Circuit..... 12

Outline Dimensions ..... 13

    Ordering Guide..... 13

**REVISION HISTORY**

**10/04—Data Sheet Changed from Rev. 0 to Rev. A**

Changes to Product Overview Section ..... 1

Changes to Figure 1 ..... 1

Changes to Electrical Characteristics Section ..... 3

Changes to Absolute Maximum Ratings Section ..... 4

Changes to Pin Configuration and Function Description..... 5

Changes to Typical Performance Characteristics Section..... 7

Changes to Applications Notes Section ..... 10

Changes to Figure 28, Typical Applications Circuit..... 12

Changes to Ordering Guide ..... 13

**8/04—Revision 0: Initial Version**

## ELECTRICAL CHARACTERISTICS

$V_{DD} = 16\text{ V}$ ,  $T_A @ 25^\circ\text{C}$ , unless otherwise noted.

**Table 1.**

Parameter	Symbol	Conditions	Min	Typ	Max	Unit
<b>BUFFER CHARACTERISTICS</b>						
<b>OUTPUTS</b>						
Output Voltage Range (Ch18 to Ch10)	$V_{OUT}$	$I_L = 100\ \mu\text{A}$	1.4		$V_{DD}$	V
Output Voltage Range (Ch9 to Ch1)	$V_{OUT}$	$I_L = 100\ \mu\text{A}$	0		$V_{DD} - 1.4$	V
Output vs. Load (Ch18, Ch17, Ch2, Ch1)	$\Delta V_{OUT}^1$	$I_L = 20\ \text{mA}$		15		mV
Output vs. Load (Ch16 to Ch3)	$\Delta V_{OUT}$	$I_L = 5\ \text{mA}$		5		mV
<b>INPUTS</b>						
Offset Voltage	$V_{OS}$			5	15	mV
Offset Voltage Drift	$\Delta V_{OS}/\Delta T$	$-40^\circ\text{C} \leq T_A \leq +105^\circ\text{C}$		20		$\mu\text{V}/^\circ\text{C}$
Input Bias Current	$I_B$	$-40^\circ\text{C} \leq T_A \leq +105^\circ\text{C}$		0.5	1.5	$\mu\text{A}$
Input Voltage Range (Ch18 to Ch10)	$V_{IN}$		1.4		$V_{DD}$	V
Input Voltage Range (Ch9 to Ch1)	$V_{IN}$		0		$V_{DD} - 1.4$	V
<b>DYNAMIC PERFORMANCE</b>						
Slew Rate	SR	$R_L = 10\ \text{k}\Omega$ , $C_L = 200\ \text{pF}$	4	6		$\text{V}/\mu\text{s}$
Bandwidth	BW	$-3\ \text{dB}$ , $R_L = 10\ \text{k}\Omega$ , $C_L = 200\ \text{pF}$		4.5		MHz
Settling Time to 0.1%	$t_s$	1 V step, $R_L = 10\ \text{k}\Omega$ , $C_L = 200\ \text{pF}$		1.1		$\mu\text{s}$
Phase Margin	$\Phi_o$	$R_L = 10\ \text{k}\Omega$ , $C_L = 200\ \text{pF}$		55		Degrees
Power Supply Rejection Ratio	PSRR	$V_{DD} = 7\ \text{V}$ to $17\ \text{V}$ , $-40^\circ\text{C} \leq T_A \leq +105^\circ\text{C}$	68	90		dB
<b>VOLTAGE REGULATOR</b>						
Programmable Range	$V_{REG\ OUT}$		5		$V_{DD} - 0.6$	V
Initial Regulator Accuracy	$V_{ACC}$	No load; $V_{REG\ OUT} = 14.4\ \text{V}$		0.4	1.5	%
Dropout Voltage	$V_{DO}$	$I_L = 100\ \mu\text{A}$		100	150	mV
		$I_L = 5\ \text{mA}$		310	350	mV
Line Regulation	$REG_{LINE}$	$V_{IN} = 8.5\ \text{V}$ to $16.5\ \text{V}$ , $V_{OUT} = 8\ \text{V}$		0.01	0.20	%/V
Load Regulation	$REG_{LOAD}$	$I_O = 100\ \mu\text{A}$ to $10\ \text{mA}$		0.02	0.10	%/mA
Maximum Load Current	$I_O$	$-40^\circ\text{C} \leq T_A \leq +105^\circ\text{C}$	5			mA
Feedback Reference Voltage	$V_{REF}$			1.2		V
Feedback Input Bias Current	$I_{BFB}$	$-40^\circ\text{C} \leq T_A \leq +105^\circ\text{C}$	-150	10	150	nA
<b>POWER SUPPLY</b>						
Supply Voltage	$V_S$		7.5		16.5	V
Supply Current	$I_{SY}$	No load, $-40^\circ\text{C} \leq T_A \leq +105^\circ\text{C}$		10.5	17	mA

<sup>1</sup>  $\Delta V_{OUT}$  is the shift from the desired output voltage under the specified current load.

## ABSOLUTE MAXIMUM RATINGS

**Table 2.**

Parameter	Rating
Supply Voltage ( $V_{DD}$ )	18 V
Input Voltage	-0.5 V to $V_{DD}$
Storage Temperature Range	-65°C to +150°C
Operating Temperature Range <sup>1</sup>	-40°C to +105°C
Junction Temperature Range	-65°C to +150°C
Lead Temperature Range (Soldering, 60 sec)	300°C
ESD Tolerance (HBM)	±2000 V
ESD Tolerance (MM)	±150 V

Stresses above those listed under Absolute Maximum Ratings may cause permanent damage to the device. This is a stress rating only; functional operation of the device at these or any other conditions above those indicated in the operational sections of this specification is not implied. Exposure to absolute maximum rating conditions for extended periods may affect device reliability.

**Table 3. Package Characteristics**

Package Type	$\theta_{JA}$	Unit
LQFP (ST)	74.57	°C/W

<sup>1</sup> See Application Notes section.

### ESD CAUTION

ESD (electrostatic discharge) sensitive device. Electrostatic charges as high as 4000 V readily accumulate on the human body and test equipment and can discharge without detection. Although this product features proprietary ESD protection circuitry, permanent damage may occur on devices subjected to high energy electrostatic discharges. Therefore, proper ESD precautions are recommended to avoid performance degradation or loss of functionality.



## PIN CONFIGURATION AND FUNCTION DESCRIPTIONS

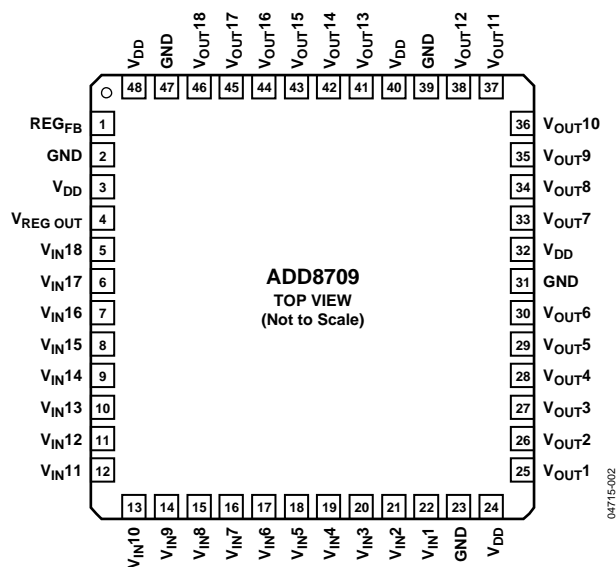

Figure 2. 48-Lead Low-Profile Quad Flat Package (ST-48)

Table 4. Pin Function Descriptions

Pin No.	Name	Description
1	REG <sub>FB</sub>	Regulator feedback. Compares a percentage of the regulator output to the internal 1.2 V voltage reference.
2	GND	Ground. Normally 0 V.
3	V <sub>DD</sub>	Supply voltage. Normally 16 V.
4	REG <sub>OUT</sub>	Regulator output voltage. Provides a regulated output voltage for use as a reference for the gamma resistors.
5	V <sub>IN18</sub>	Buffer inputs. An external resistor calculator is available upon request from your local sales office.
6	V <sub>IN17</sub>	
7	V <sub>IN16</sub>	
8	V <sub>IN15</sub>	
9	V <sub>IN14</sub>	
10	V <sub>IN13</sub>	
11	V <sub>IN12</sub>	
12	V <sub>IN11</sub>	
13	V <sub>IN10</sub>	
14	V <sub>IN9</sub>	
15	V <sub>IN8</sub>	
16	V <sub>IN7</sub>	
17	V <sub>IN6</sub>	
18	V <sub>IN5</sub>	
19	V <sub>IN4</sub>	
20	V <sub>IN3</sub>	
21	V <sub>IN2</sub>	
22	V <sub>IN1</sub>	
23	GND	Ground. Normally 0 V.
24	V <sub>DD</sub>	Supply voltage. Normally 16 V.
25	V <sub>OUT1</sub>	Buffer outputs. These buffers can swing to ground.
26	V <sub>OUT2</sub>	

# ADD8709

Pin No.	Name	Description
27	V <sub>OUT3</sub>	Buffer outputs. These buffers can swing to ground.
28	V <sub>OUT4</sub>	
29	V <sub>OUT5</sub>	
30	V <sub>OUT6</sub>	
31	GND	Ground. Normally 0 V.
32	V <sub>DD</sub>	Supply voltage. Normally 16 V.
33	V <sub>OUT7</sub>	Buffer outputs. These buffers can swing to ground.
34	V <sub>OUT8</sub>	
35	V <sub>OUT9</sub>	
36	V <sub>OUT10</sub>	Buffer outputs. These buffers can swing to V <sub>DD</sub> .
37	V <sub>OUT11</sub>	
38	V <sub>OUT12</sub>	
39	GND	Ground. Normally 0 V.
40	V <sub>DD</sub>	Supply Voltage. Normally 16V.
41	V <sub>OUT13</sub>	Buffer outputs. These buffers can swing to V <sub>DD</sub> .
42	V <sub>OUT14</sub>	
43	V <sub>OUT15</sub>	
44	V <sub>OUT16</sub>	
45	V <sub>OUT17</sub>	
46	V <sub>OUT18</sub>	
47	GND	Ground. Normally 0 V.
48	V <sub>DD</sub>	Supply voltage. Normally 16 V.

# TYPICAL PERFORMANCE CHARACTERISTICS

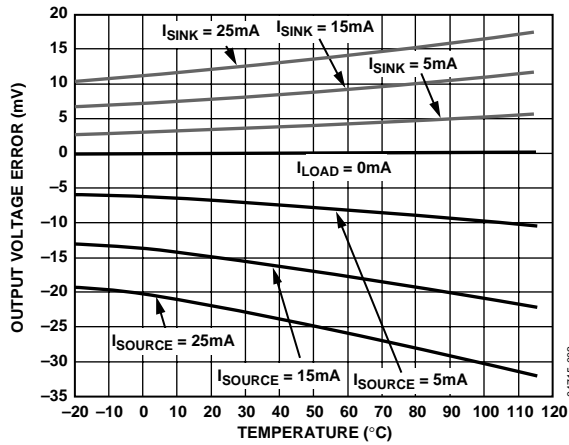

Figure 3. Output Voltage Error vs. Temperature

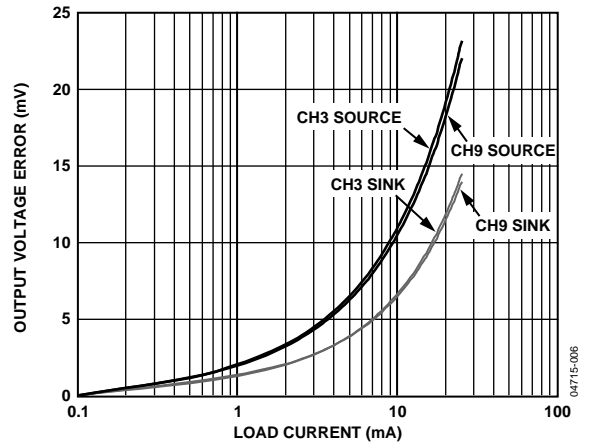

Figure 6. Output Voltage Error vs. Load Current (Channels 3 and 9)

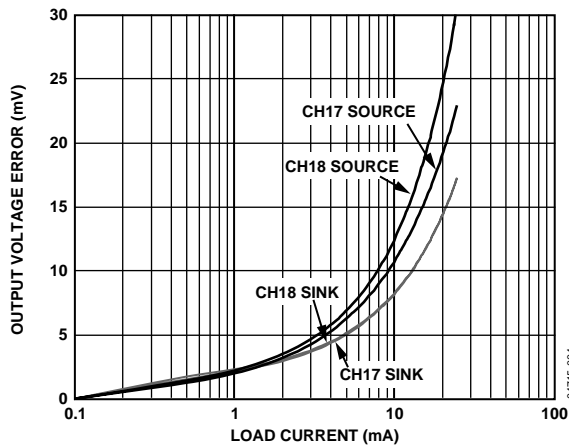

Figure 4. Output Voltage Error vs. Load Current (Channels 17 and 18)

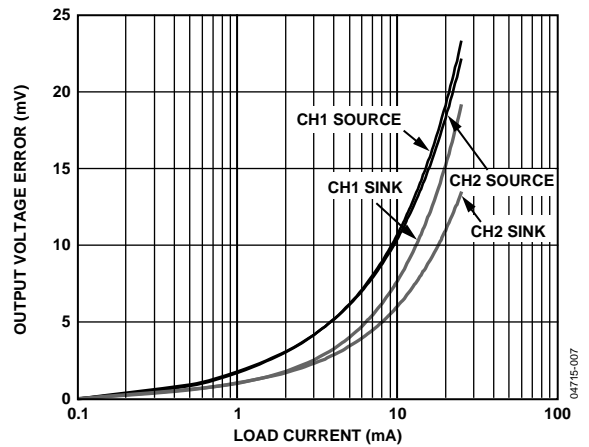

Figure 7. Output Voltage Error vs. Load Current (Channels 1 and 2)

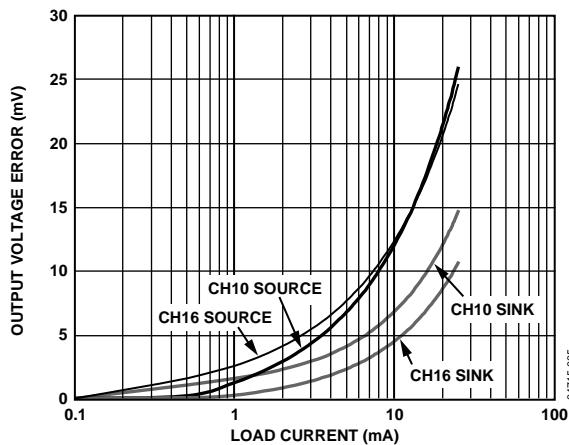

Figure 5. Output Voltage Error vs. Load Current (Channels 10 and 16)

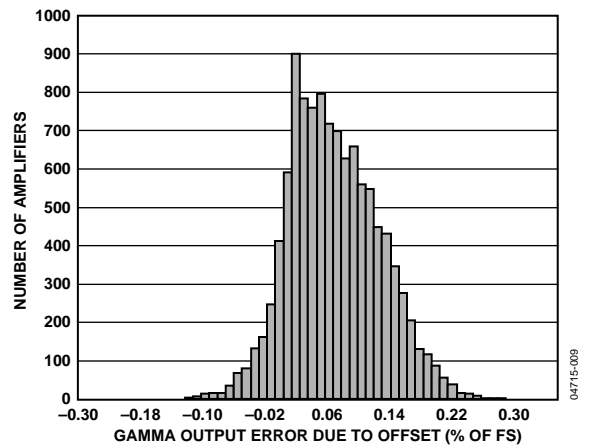

Figure 8. Gamma Output Voltage Error

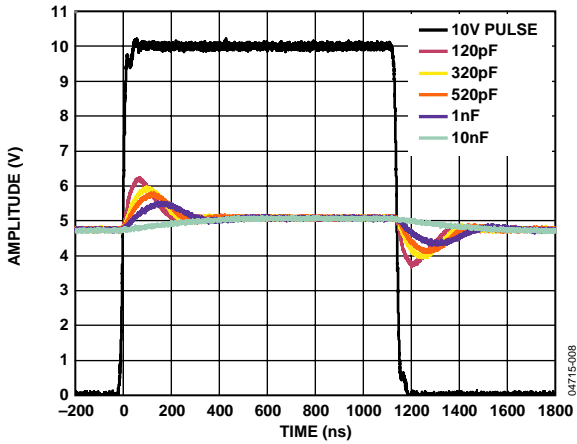

Figure 9. Gamma Buffers Load Transient Response vs. Capacitive Loading

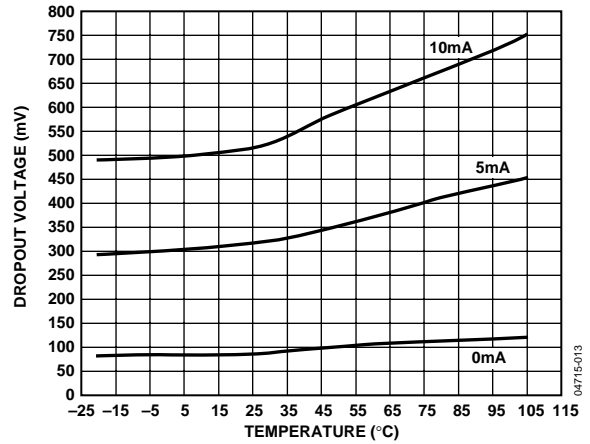

Figure 12. Dropout Voltage vs. Temperature

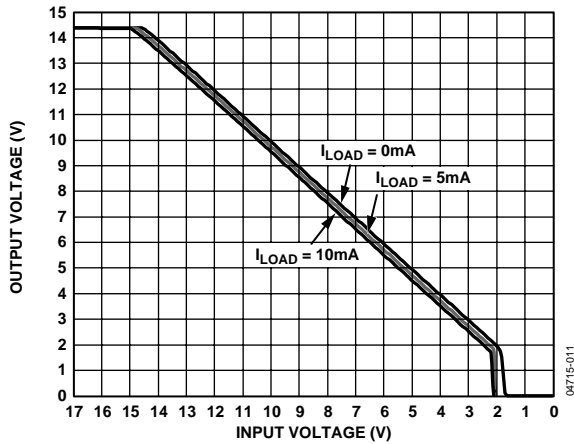

Figure 10. Dropout Characteristics

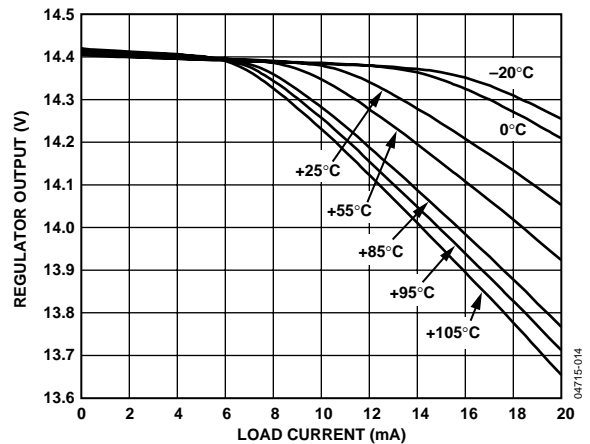

Figure 13. Regulator Output vs.  $I_{LOAD}$  over Temperature

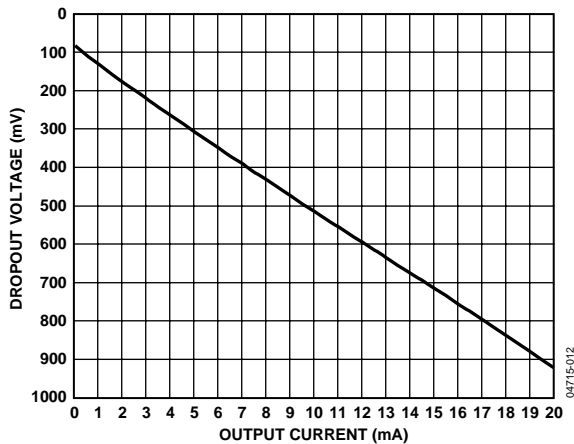

Figure 11. Dropout Voltage vs. Output Current

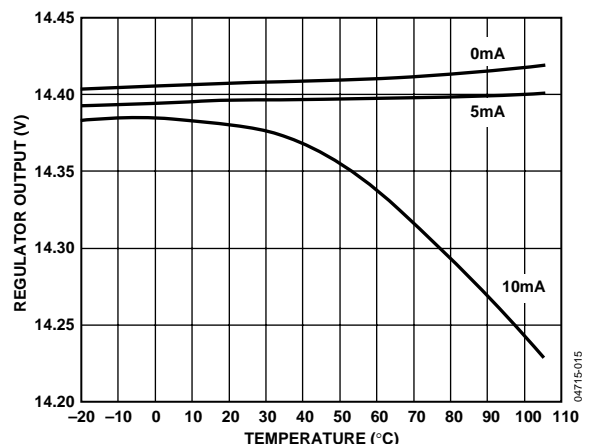

Figure 14. Regulator Output vs. Temperature



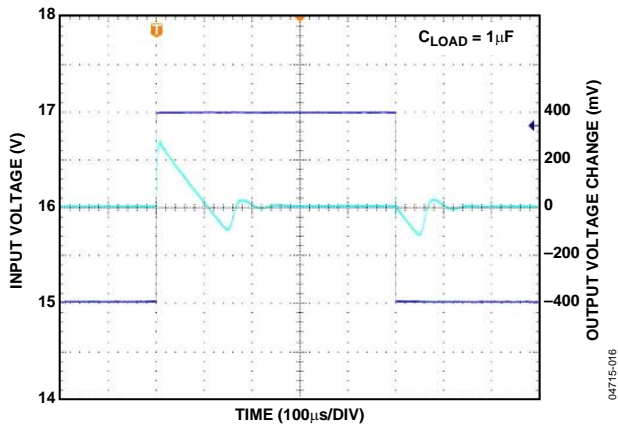

Figure 15. Regulator Line Transient Response

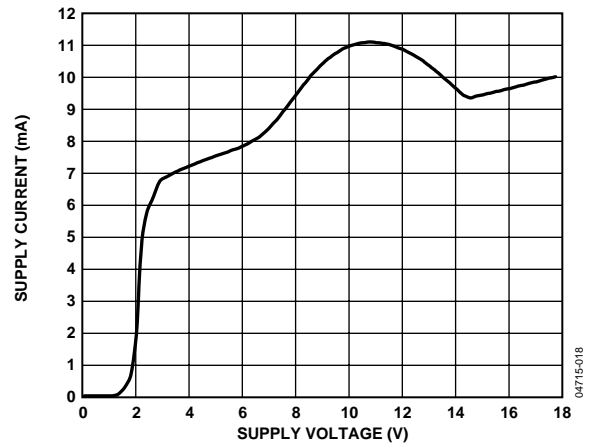

Figure 17. Supply Current vs. Supply Voltage

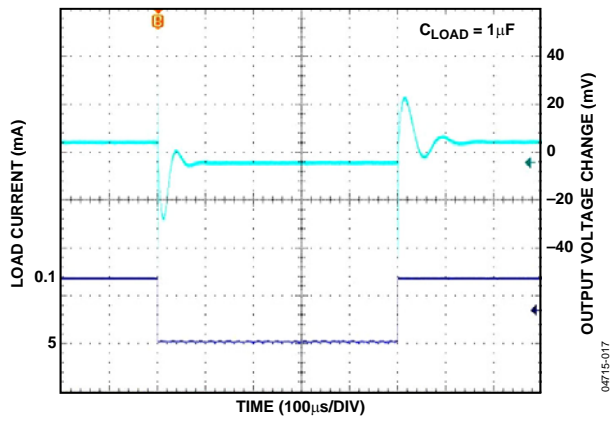

Figure 16. Regulator Load Transient Response

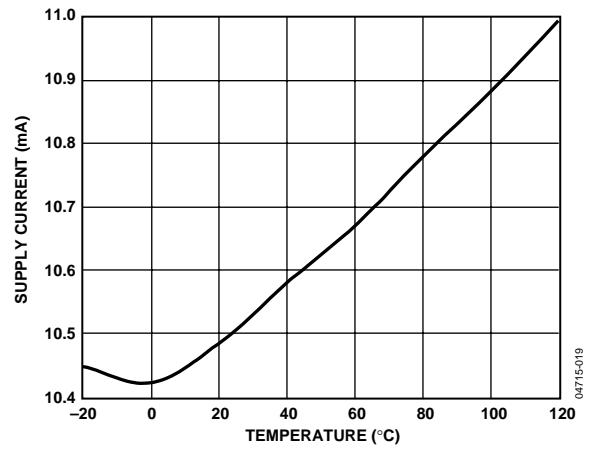

Figure 18. Supply Current vs. Temperature

## APPLICATION NOTES

The ADD8709 is a gamma reference generator that allows source drivers to be optimized for the different combinations of liquid crystals, glass sizes, etc. in large LCD panels.

In a typical panel application, the selected source drivers have an internal gamma curve that is not ideal for the specific panel, as shown in Figure 19. The ADD8709 allows the gamma curve in the source drivers to be adjusted appropriately, and also ensures that all of the source drivers have the same gamma curve.

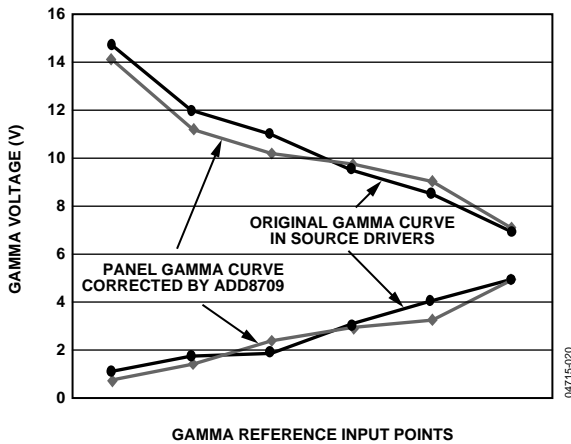

Figure 19. Original and Corrected Gamma Curves

The ADD8709 also includes a low dropout linear regulator to provide a stable reference level for the gamma curve for best panel performance.

### VOLTAGE REGULATOR

The on-board voltage regulator provides a regulated voltage to the external resistors to set different gamma voltages.

The output of the regulator is set by the two resistors,  $R_1$  and  $R_2$ , and an internal reference voltage of 1.2V. In the ADD8709,  $R_1$  and  $R_2$  are external components. The output voltage can be found by

$$V_{REG\ OUT} = V_{REF} \times (R_2/R_1 + 1)$$

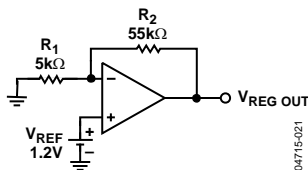

Figure 20. Voltage Regulator

### MAXIMUM POWER DISSIPATION

The maximum safe power dissipation in the ADD8709 package is limited by the associated rise in junction temperature ( $T_J$ ) on the die. At approximately 150°C, the glass transition temperature, the properties of the plastic change. Even temporarily exceeding this temperature limit may change the stresses that the package exerts on the die, permanently shifting the parametric performance of the ADD8709. Exceeding a junction temperature of 175°C for an extended period can result in changes in the silicon devices, potentially causing failure.

### OPERATING TEMPERATURE RANGE

The junction temperature is

$$T_J = T_{AMB} + \theta_{JA} \times P_{DIS}$$

where:

$T_{AMB}$  = ambient temperature.

$\theta_{JA}$  = junction-to-ambient thermal resistance, in °C/watt.

$P_{DIS}$  = power dissipated in the device, in watts.

For the ADD8709,  $P_{DIS}$  can be calculated by

$$P_{DIS} = V_{DD} \times I_{DQ} + \Sigma(I_{OUT\ X(+)} \times (V_{DD} - V_{OUT\ X})) + \Sigma(-I_{OUT\ X(-)} \times V_{OUT\ X}) + (V_{DD} - V_{REG\ OUT}) \times I_{LOAD}$$

where:

$V_{DD} \times I_{DQ}$  = nominal system power requirements.

$I_{OUT\ X(+)} \times (V_{DD} - V_{OUT\ X})$  = positive-current amplifier load power dissipation (current comes from  $V_{DD}$ ).

$-I_{OUT\ X(-)} \times V_{OUT\ X}$  = negative-current amplifier load power dissipation (current goes to GND).

$(V_{DD} - V_{REG\ OUT}) \times I_{LOAD}$  = regulator load power dissipation.

### Example 1

To calculate an estimated power consumption of the ADD8709 assume:

$$V_{DD} \times I_{DQ} = 16\text{ V} \times 15\text{ mA} = 0.240\text{ W.}$$

$$(V_{DD} - V_{REG\ OUT}) \times I_{LOAD} = (16\text{ V} - 14.4\text{ V}) \times 5\text{ mA} = 0.008\text{ W.}$$

Table 5.

	<b>V<sub>OUTx</sub> (V)</b>	<b>I<sub>OUTx</sub> (mA)</b>	<b>P (W)</b>
V <sub>OUT18</sub>	14.400	4.3	0.00688
V <sub>OUT17</sub>	11.405	5.2	0.0239
V <sub>OUT16</sub>	10.627	-4.4	0.0468
V <sub>OUT15</sub>	10.397	7.3	0.0409
V <sub>OUT14</sub>	10.195	7.6	0.0441
V <sub>OUT13</sub>	10.080	-3.9	0.0393
V <sub>OUT12</sub>	9.821	8.3	0.0513
V <sub>OUT11</sub>	9.130	7.9	0.0543
V <sub>OUT10</sub>	8.611	-4.5	0.0389
V <sub>OUT9</sub>	6.480	-4.2	0.0272
V <sub>OUT8</sub>	6.077	5.6	0.0556
V <sub>OUT7</sub>	5.098	-3.3	0.0168
V <sub>OUT6</sub>	4.810	-6.9	0.0332
V <sub>OUT5</sub>	4.694	5.7	0.0644
V <sub>OUT4</sub>	4.435	3.5	0.0405
V <sub>OUT3</sub>	4.205	9.6	0.113
V <sub>OUT2</sub>	3.398	-9.5	0.0323
V <sub>OUT1</sub>	0.202	-7.2	0.00145
$\Sigma(I_{OUTx(+)} \times (V_{DD} - V_{OUTx})) + \Sigma(-I_{OUTx(+)} \times V_{OUTx})$			0.731

$$P_{DIS} = 0.240 \text{ W} + 0.731 \text{ W} + 0.008 \text{ W} = 0.979 \text{ W}$$

$$\theta_{JA} = 74.57^\circ\text{C/W}, T_{AMB} = 45^\circ\text{C}$$

$$T_J = 45^\circ\text{C} + (74.57^\circ\text{C/W}) \times (0.979 \text{ W}) = 118.0^\circ\text{C}$$

Here, 150°C is the maximum junction temperature that is guaranteed before the part breaks down, while 125°C is the maximum process limit. Because  $T_J$  is < 150°C and < 125°C, this example demonstrates a condition where the part should perform within process limits.

TYPICAL APPLICATIONS CIRCUIT

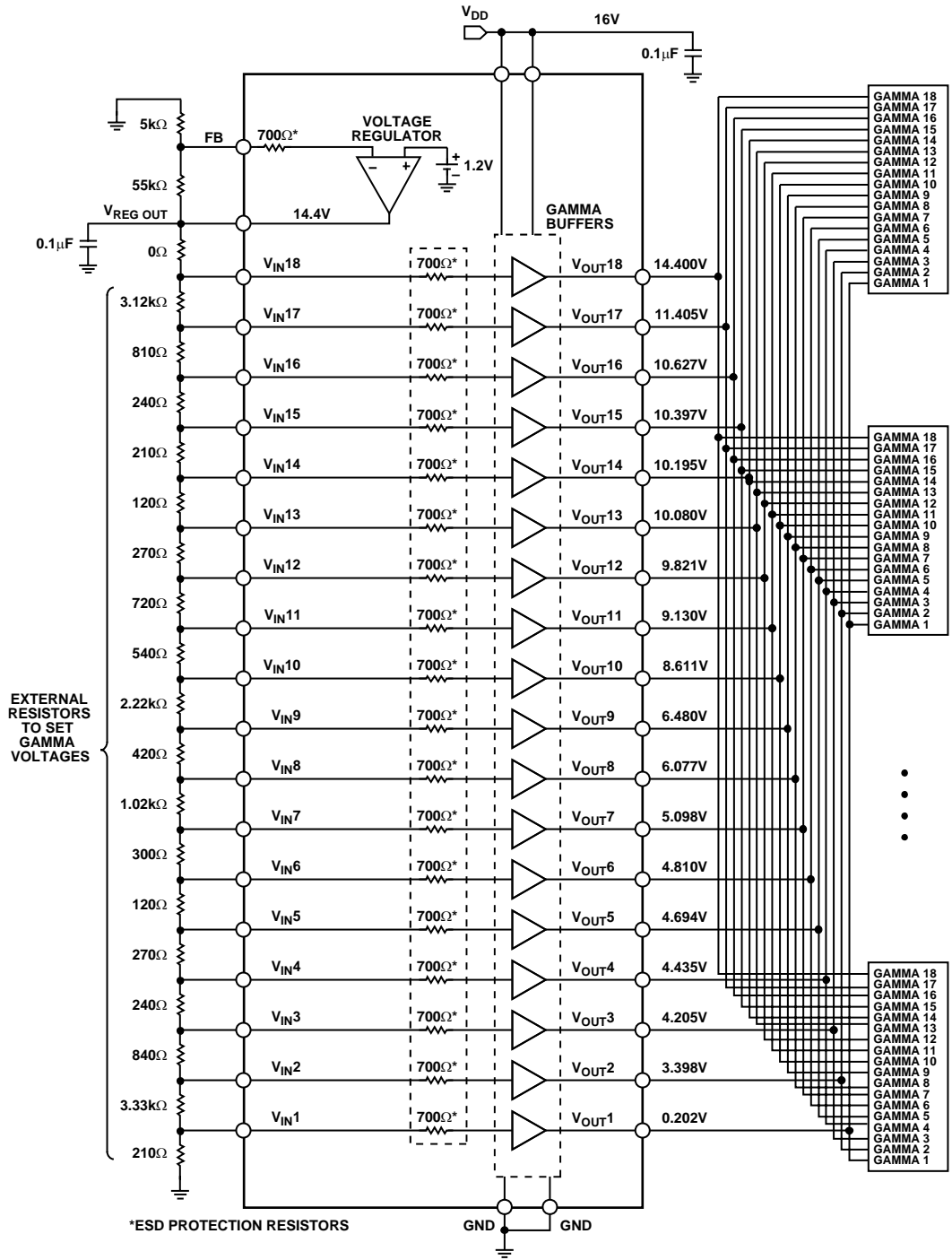
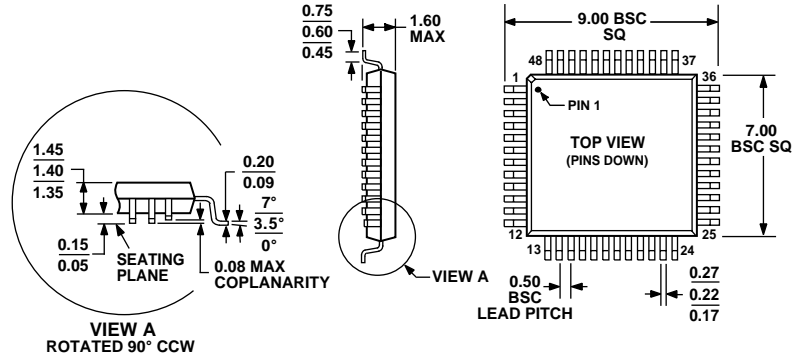

Figure 21. Typical Applications Circuit

04715-022

# OUTLINE DIMENSIONS



COMPLIANT TO JEDEC STANDARDS MS-026BBC

Figure 22. 48-Lead Low Profile Quad Flat Package [LQFP] (ST-48)  
Dimensions shown in millimeters

## ORDERING GUIDE

Model <sup>1</sup>	Temperature Range	Package Description	Package Option
ADD8709ASTZ-REEL <sup>2,3</sup>	-40°C to +100°C	48-Lead Low Profile Quad Flat Package	ST-48
ADD8709ASTZ-REEL <sup>7,3</sup>	-40°C to +100°C	48-Lead Low Profile Quad Flat Package	ST-48
ADD8709WSTZ-REEL <sup>2</sup>	-40°C to +105°C	48-Lead Low Profile Quad Flat Package	ST-48
ADD8709WSTZ-REEL <sup>7,2</sup>	-40°C to +105°C	48-Lead Low Profile Quad Flat Package	ST-48

<sup>1</sup> Available in reels only.

<sup>2</sup> Z = Pb-free part.

<sup>3</sup> WARNING: Not to be used in new design. Option for existing designs only.

**ADD8709**

**NOTES**

**NOTES**

**ADD8709**

**NOTES**